



Main

Range of product	Telemecanique Cabling components
Accessory / separate part category	Cabling accessory
Accessory / separate part type	Pre-wired connectors
Series name	General purpose

Complementary

Electrical connection	Elbowed female connector M12, 4 pins
Cable connector fixing	Screw-on
Collar material	Metal
Status LED	Without
Cable length	5 m
Cable outer diameter	5.2 mm
Cable composition	4 x 0.34 mm ²
Wire insulation material	PUR
[Ue] rated operational voltage	250 V AC 300 V DC
[In] rated current	4 A
Contact resistance	5000 µOhm
Minimum insulating resistance	1 GΩ
Net weight	0.19 kg

Environment

IP degree of protection	IP65 IP67 IP69K
Product certifications	cULus
Ambient air temperature for operation	-40...80 °C static -5...80 °C flexing
Ambient air temperature for storage	-40...80 °C

Packing Units

Unit Type of Package 1	PCE
Number of Units in Package 1	1
Package 1 Height	2.0 cm
Package 1 Width	18.5 cm
Package 1 Length	19.0 cm
Package 1 Weight	155.0 g
Unit Type of Package 2	S02
Number of Units in Package 2	20
Package 2 Height	15.0 cm
Package 2 Width	30.0 cm

Package 2 Length	40.0 cm
Package 2 Weight	3.428 kg
Unit Type of Package 3	P06
Number of Units in Package 3	320
Package 3 Height	77.0 cm
Package 3 Width	80.0 cm
Package 3 Length	60.0 cm
Package 3 Weight	55.6 kg

Offer Sustainability

Sustainable offer status	Green Premium product
California proposition 65	WARNING: This product can expose you to chemicals including: Diisononyl phthalate (DINP), which is known to the State of California to cause cancer, and Di-isodecyl phthalate (DIDP), which is known to the State of California to cause birth defects or other reproductive harm. For more information go to www.P65Warnings.ca.gov
For all Reach Rohs enquiries contact us at	sustainability@tesensors.com

Contractual warranty

Warranty	18 months
----------	-----------

Dimensions

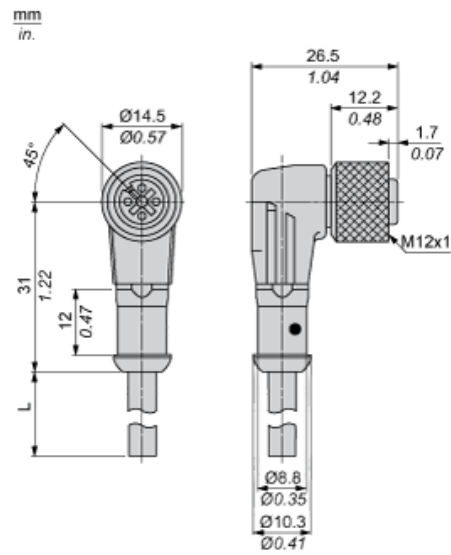

L : Length of cable

Connections and Schemes

Connector

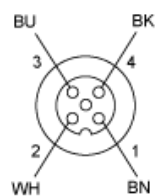

BN : Brown
BK : Black
BU : Blue
WH : White