

# XUM9ANSBL2

Photoelectric sensors XU, miniature, reflex,  
Sn=6 m, NPN, cable 2 m



## Main

Range of product	Telemecanique Photoelectric sensors XU
Series name	General purpose single mode
Electronic sensor type	Photo-electric sensor
Sensor name	XUM
Sensor design	Miniature
Detection system	Polarised reflex
Material	Plastic
Type of output signal	Discrete
Supply circuit type	DC
Wiring technique	3-wire
Discrete output type	NPN
Discrete output function	1 NO or 1 NC programmable
Electrical connection	Cable
Cable length	2 m
Emission	Red LED polarised reflex
[Sn] nominal sensing distance	6 m with reflector 50 x 50 mm

## Complementary

Enclosure material	PBT
Lens material	PMMA
Output type	Solid state
Wire insulation material	PVC
Status LED	Stability: 1 LED (green) Output state: 1 LED (yellow)
[Us] rated supply voltage	12...24 V DC with reverse polarity protection
Supply voltage limits	10...30 V DC
Switching capacity in mA	<= 100 mA with short-circuit protection
Switching frequency	<= 500 Hz
Maximum voltage drop	<2 V
Current consumption	30 mA no-load
Maximum delay first up	300 ms
Maximum delay response	1 ms
Setting-up	Sensitivity by potentiometer
Depth	19.5 mm
Height	31.5 mm
Width	10.8 mm
Net weight	0.050 kg

## Environment

Product certifications	UL[RETURN]CE
Ambient air temperature for operation	-25...55 °C
Ambient air temperature for storage	-40...70 °C
Vibration resistance	+/-0.5 mm (f = 10...55 Hz) for every axis conforming to IEC 60068-2-6
Shock resistance	30 gn for for every axis conforming to IEC 60068-2-27
IP degree of protection	IP67 conforming to IEC 60529 IP54 conforming to IEC 60529

## Packing Units

Unit Type of Package 1	PCE
Number of Units in Package 1	1
Package 1 Height	2.000 cm
Package 1 Width	13.500 cm
Package 1 Length	12.500 cm
Package 1 Weight	68.000 g
Unit Type of Package 2	S01
Number of Units in Package 2	30
Package 2 Height	15.000 cm
Package 2 Width	15.000 cm
Package 2 Length	40.000 cm
Package 2 Weight	2.297 kg

## Offer Sustainability

Toxic heavy metal free	Yes
California proposition 65	WARNING: This product can expose you to chemicals including: Diisononyl phthalate (DINP), which is known to the State of California to cause cancer, and Diisodecyl phthalate (DIDP), which is known to the State of California to cause birth defects or other reproductive harm. For more information go to <a href="http://www.P65Warnings.ca.gov">www.P65Warnings.ca.gov</a>
For all Reach Rohs enquiries contact us at	<a href="mailto:sustainability@tesensors.com">sustainability@tesensors.com</a>

Dimensions

Pre-cable Version

Description

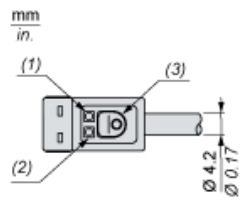

Dimensions

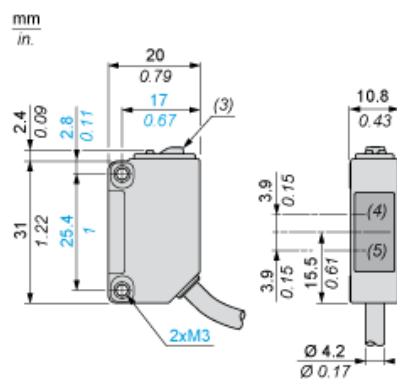

- (1) Output indicator (orange)
- (2) Stability indicator (green)
- (3) Setting pushbutton
- (4) Reception
- (5) Transmission

---

## Connections and Schema

---

### Pre-cabled

(-) : BU (Blue)

(+) : BN (Brown)

OUT/Output : BK (Black)

---

## Connections and Schema

---

### NPN

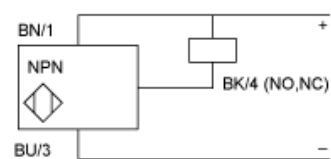

BN : Brown

BU : Blue

BK : Black

---

## Mounting and Clearance

---

### Tightening Torque

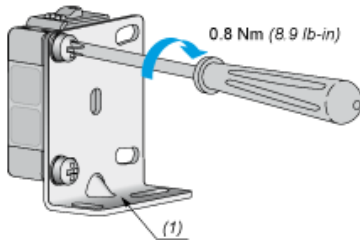

(1) Base mounting fixing bracket

Performance Curves

Polarised Reflex System

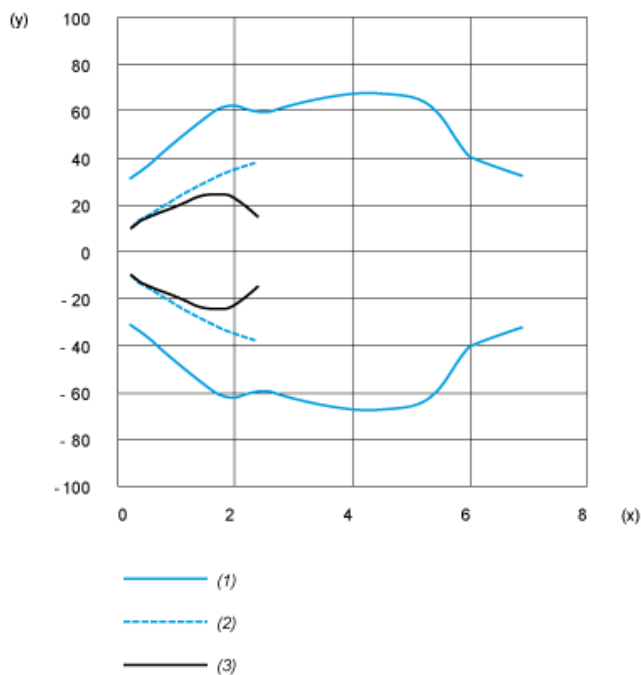

- (1) With XUZC50 reflector
- (2) With XUZC08 reflector (horizontally placed)
- (3) With XUZC08 reflector (vertically placed)
- (y) Parallel movement in mm
- (x) Distance in m

With Horizontally Placed Reflector

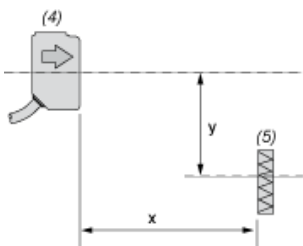

- (4) Sensor
- (5) Reflector

With Vertically Placed Reflector

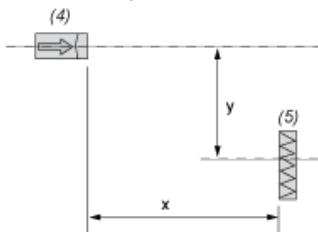

- (4) Sensor
- (5) Reflector