

XUK0AKSAL2

Photoelectric sensors XU, XUK, multi, Sn 0...30 m, 12...24 VDC, cable 2 m



Main

Range of product	Telemecanique Photoelectric sensors XU
Series name	General purpose multimode
Electronic sensor type	Photo-electric sensor
Sensor name	XUK
Sensor design	Compact 50 x 50
Detection system	Multimode
Material	Plastic
Type of output signal	Discrete
Supply circuit type	DC
Wiring technique	3-wire
Discrete output type	PNP or NPN
Discrete output function	1 NO or 1 NC programmable
Electrical connection	Cable
Cable length	2 m
Product specific application	-
Emission	Infrared diffuse Infrared diffuse with background suppression Infrared thru beam Red polarised reflex
[Sn] nominal sensing distance	4 M polarised reflex need reflector XUZC50 30 M thru beam need a transmitter XUK0AKSAL2T 0.28 M diffuse with background suppression 0.8 m diffuse

Complementary

Enclosure material	PBT
Lens material	PMMA
Maximum sensing distance	35 M thru beam 0.28 M diffuse with background suppression 1.2 M diffuse 5.7 m polarised reflex
Output type	Solid state
Add on output	With alarm output, <= 50 mA with overload and short-circuit protection
Wire insulation material	PvR
Status LED	1 LED (green) for supply 1 LED (red) for instability 1 LED (yellow) for output state
[Us] rated supply voltage	12...24 V DC with reverse polarity protection
Supply voltage limits	10...36 V DC
Switching capacity in mA	<= 100 mA (overload and short-circuit protection)
Switching frequency	<= 250 Hz
Maximum voltage drop	<1.5 V (closed state)
Current consumption	<= 35 mA no-load
Maximum delay first up	200 ms
Maximum delay response	2 ms
Maximum delay recovery	2 ms
Setting-up	Self-teaching
Depth	50 mm
Height	50 mm

Width	18 mm
Net weight	0.175 kg

Environment

Product certifications	CSA[RETURN]UL[RETURN]CE
Ambient air temperature for operation	-25...55 °C
Ambient air temperature for storage	-40...70 °C
Vibration resistance	7 gn, amplitude = +/- 1.5 mm (f = 10...55 Hz) conforming to IEC 60068-2-6
Shock resistance	30 gn (duration = 11 ms) conforming to IEC 60068-2-27
IP degree of protection	IP65 double insulation conforming to IEC 60529

Packing Units

Unit Type of Package 1	PCE
Number of Units in Package 1	1
Package 1 Height	13.2 cm
Package 1 Width	9.5 cm
Package 1 Length	4.2 cm
Package 1 Weight	166.0 g
Unit Type of Package 2	S02
Number of Units in Package 2	22
Package 2 Height	15 cm
Package 2 Width	30 cm
Package 2 Length	40 cm
Package 2 Weight	4.018 kg
Unit Type of Package 3	P06
Number of Units in Package 3	352
Package 3 Height	75 cm
Package 3 Width	60 cm
Package 3 Length	80 cm
Package 3 Weight	71 kg

Offer Sustainability

Sustainable offer status	Green Premium product
California proposition 65	WARNING: This product can expose you to chemicals including: Diisononyl phthalate (DINP), which is known to the State of California to cause cancer, and Di-isodecyl phthalate (DIDP), which is known to the State of California to cause birth defects or other reproductive harm. For more information go to www.P65Warnings.ca.gov
For all Reach Rohs enquiries contact us at	sustainability@tesensors.com

Contractual warranty

Warranty	18 months
----------	-----------

Dimensions

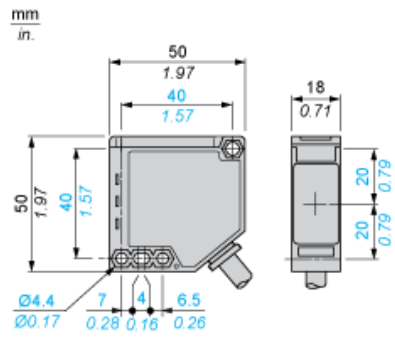

Wiring Schemes

PNP Output

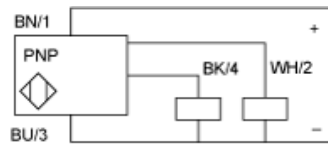

(+) Brown
BN :
(-) Blue
BU :
(OUT)Black
Output)
BK :
(Alarm)White
WH :

NPN Output

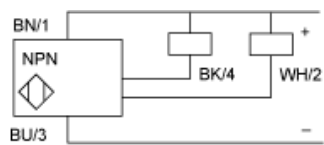

(+) Brown
BN :
(-) Blue
BU :
(OUT)Black
Output)
BK :
(Alarm)White
WH :

Detection Curves

With Thru-beam Accessory (Thru-beam)

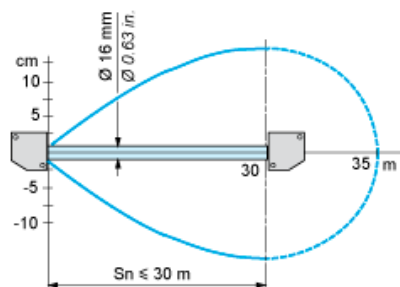

Without Accessory (Diffuse)

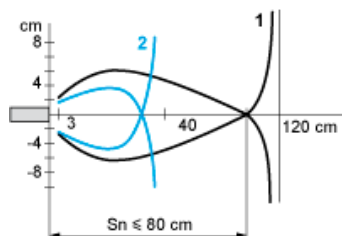

- 1 : White 90%
 - 2 : Grey 18%
- Object 10 x 10 cm

Without Accessory (Diffuse with background suppression)

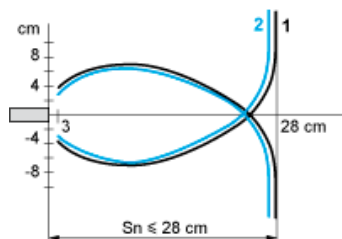

- 1 : White 90%
 - 2 : Grey 18%
- Object 10 x 10 cm

With reflector (Polarised reflex)

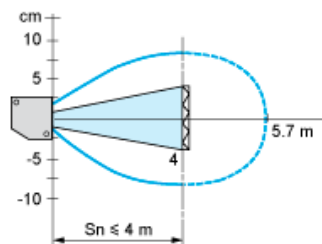

With reflector XUZC50

Variation of Usable Sensing Distance S_u (Without accessory, with adjustable background suppression)

Teach Mode at Minimum

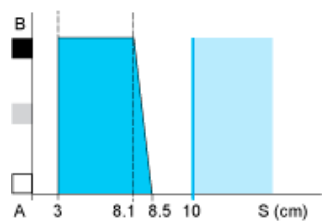

Teach Mode at Maximum

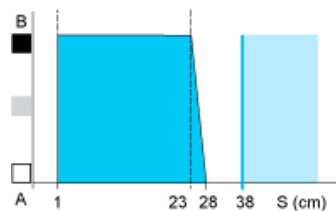

- (1) Black
- (2) Grey
- (3) White
- (4) Sensing range
- (5) Non sensing zone (matt surfaces)

A-B : Object reflection coefficient

- (1) Black 6%
- (2) Grey 18%
- (3) White 90%
- (4) Sensing range
- (5) Non sensing zone (matt surfaces)