

# XT230A2MDB

Capacitive proximity sensors XT, cylindrical  
M30, plastic, Sn 15 mm, 24...240 V AC



## Main

Range of product	Telemecanique Capacitive proximity sensors XT
Sensor type	Capacitive proximity sensor
Product specific application	Animal feeding Detection of insulated or conductive materials
Sensor name	XT2
Sensor design	Cylindrical M30
Size	100 mm
Body type	Fixed
Detector flush mounting acceptance	Non flush mountable
Material	Plastic
Enclosure material	Plastic
Type of output signal	Discrete
Wiring technique	2-wire
[Sn] nominal sensing distance	15 mm
Discrete output function	1 NO or 1 NC programmable
Output circuit type	AC DC
Electrical connection	Screw clamp terminal
[Us] rated supply voltage	24...240 V AC 50...60 Hz
Maximum delay response	10 ms
IP degree of protection	IP65 conforming to IEC 60529

## Complementary

ISO thread	M30 x 1.5
Detection face	Frontal
[Sa] assured operating distance	0...11 mm
Adjustment zone	0...17 mm
Differential travel	< 1...15 % Sr
Repeat accuracy	< 5 % Sr
Cable entry	1 entry incorporating cable gland, cable outer diameter: 7...13 mm
Status LED	Output state indication: 1 LED (yellow)
Supply voltage limits	20...265 V AC
Maximum residual current	120 mA open state
Switching frequency	<= 40 Hz
Maximum voltage drop	<2 V (closed)
Current consumption	< 3 mA
Maximum delay first up	100 ms
Maximum delay recovery	10 ms
Maximum switching current	300 mA
Marking	CE
Setting-up	Sensitivity by potentiometer
Threaded length	45 mm
Length	100 mm
Net weight	0.1 kg

## Environment

Standards	IEC 60947-5-2 UL 61010-1
Product certifications	cULus
Ambient air temperature for operation	-20...70 °C
Ambient air temperature for storage	-40...85 °C
Electrical insulation class	Class I
Vibration resistance	10 gn amplitude = 1 mm (f = 10...55 Hz) conforming to IEC 60068-2-6
Shock resistance	30 gn for 11 ms conforming to IEC 60068-2-27
Resistance to electrostatic discharge	4 kV contact conforming to IEC 61000-4-2 8 kV air conforming to IEC 61000-4-2
Resistance to electromagnetic fields	3 V/m conforming to IEC 61000-4-3
Resistance to fast transients	2 kV conforming to IEC 61000-4-4

## Packing Units

Unit Type of Package 1	PCE
Number of Units in Package 1	1
Package 1 Height	5.0 cm
Package 1 Width	6.0 cm
Package 1 Length	12.0 cm
Package 1 Weight	100.0 g
Unit Type of Package 2	S02
Number of Units in Package 2	60
Package 2 Height	15.0 cm
Package 2 Width	30.0 cm
Package 2 Length	40.0 cm
Package 2 Weight	6.243 kg

## Offer Sustainability

Toxic heavy metal free	Yes
California proposition 65	WARNING: This product can expose you to chemicals including: Diisononyl phthalate (DINP), which is known to the State of California to cause cancer, and Di-isodecyl phthalate (DIDP), which is known to the State of California to cause birth defects or other reproductive harm. For more information go to <a href="http://www.P65Warnings.ca.gov">www.P65Warnings.ca.gov</a>
For all Reach Rohs enquiries contact us at	<a href="mailto:sustainability@tesensors.com">sustainability@tesensors.com</a>

## Contractual warranty

Warranty	18 months
----------	-----------

Dimensions

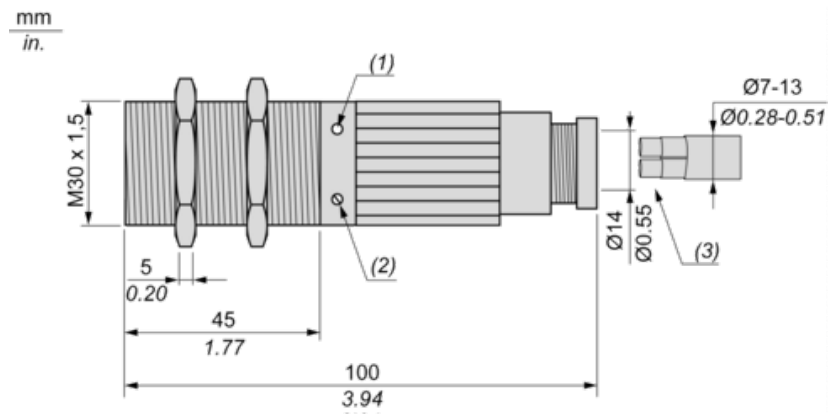

---

## Setting-up

---

### Minimum Mounting Distances (mm)

Side by side

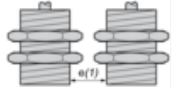

$$e(1) \geq 16$$

Face to face

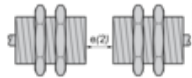

$$e(2) \geq 1350$$

Facing a metal object

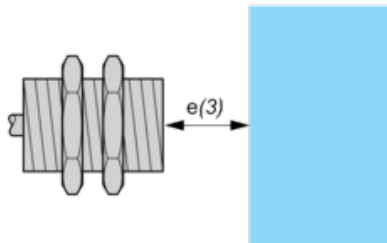

$$e(3) \geq 675$$

Mounted in support

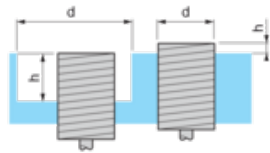

$$d \geq 90$$

$$h \geq 30$$

Fixing nut tightening torque: 4 N.m

---

## Adjustment

---

### Sensitivity Adjustment

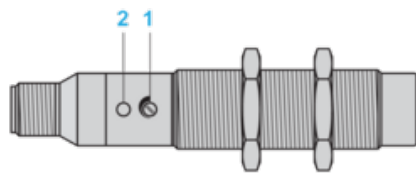

(1) Adjustment potentiometer

(2) LED

---

## Wiring Diagram

---

### Screw Terminal Version

2-wire AC NO or NC Output, Selectable

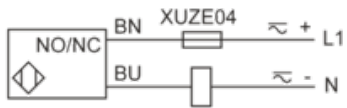

(BN) Brown

(BU) Blue