

XSAV32373L10

Inductive proximity sensors XS, Rotation monitoring, M30, Sn10mm, 120...3000c/mn, 12...48 VDC, cable 10 m



Main

Range of product	Telemecanique Inductive proximity sensors XS
Series name	Application
Product or component type	Sensor
Sensor type	Inductive proximity sensor
Device application	Rotation monitoring
Sensor name	XSA
Sensor design	Cylindrical M30
Size	81 mm
Body type	Fixed
Detector flush mounting acceptance	Flush mountable
Material	Metal
Enclosure material	Nickel plated brass
Type of output signal	Discrete
Wiring technique	3-wire
[Sn] nominal sensing distance	10 mm
Discrete output function	1 NC
Output circuit type	DC
Discrete output type	PNP
Electrical connection	Cable
Cable length	10 m
[Us] rated supply voltage	12...48 V DC with reverse polarity protection
Switching capacity in mA	<= 200 mA with overload and short-circuit protection
IP degree of protection	IP67 conforming to IEC 60529

Complementary

Thread type	M30 x 1.5
Detection face	Frontal
Front material	PPS
Sensing range	> 8...15 mm
Adjustable frequency range	120...3000 cyc/mn
Operating zone	0...8 mm
Differential travel	3...15% of Fr
Repeat accuracy	3% of Sr
Cable composition	3 x 0.34 mm ²
Wire insulation material	PVC
Status LED	Output state: 1 LED (red)
Supply voltage limits	10...58 V DC
Maximum residual current	1.5 mA open state
Switching frequency	<= 800 Hz
Maximum voltage drop	<1.8 V (closed)
Current consumption	0...15 mA no-load
Run-up delay at power-up	3 s reduce

Marking	CE
Threaded length	67 mm
Length	81 mm
Net weight	0.3 kg

Environment

Product certifications	UL[RETURN]CSA[RETURN]CCC
Ambient air temperature for operation	-25...70 °C
Ambient air temperature for storage	-40...85 °C

Packing Units

Unit Type of Package 1	PCE
Number of Units in Package 1	1
Package 1 Height	13 cm
Package 1 Width	6.5 cm
Package 1 Length	9.5 cm
Package 1 Weight	642 g

Offer Sustainability

Sustainable offer status	Green Premium product
Circularity Profile	 End of Life Information
California proposition 65	WARNING: This product can expose you to chemicals including: Diisononyl phthalate (DINP), which is known to the State of California to cause cancer, and Di-isodecyl phthalate (DIDP), which is known to the State of California to cause birth defects or other reproductive harm. For more information go to www.P65Warnings.ca.gov
For all Reach Rohs enquiries contact us at	sustainability@tesensors.com

Contractual warranty

Warranty	18 months
----------	-----------

Dimensions

mm
in.

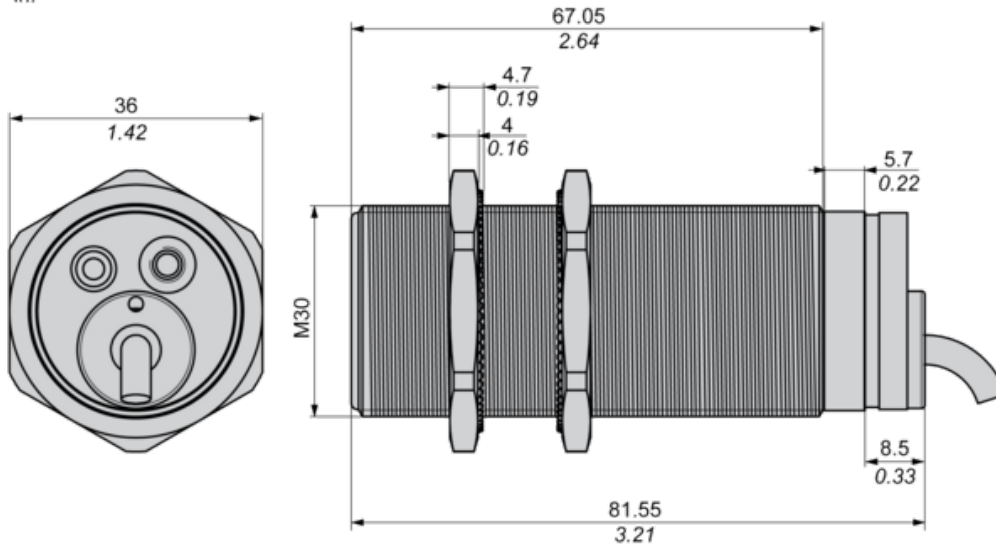

(1) LED

Minimum Mounting Distances

Side by side

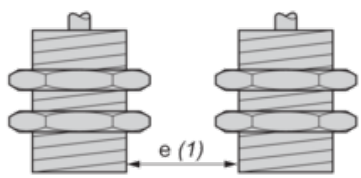

$e (1) \geq 20 \text{ mm}/0.79 \text{ in}$

Face to face

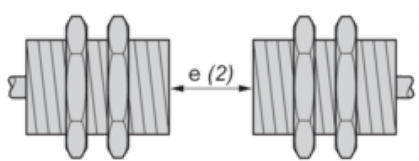

$e (2) \geq 120 \text{ mm}/4.72 \text{ in}$

Facing a metal object

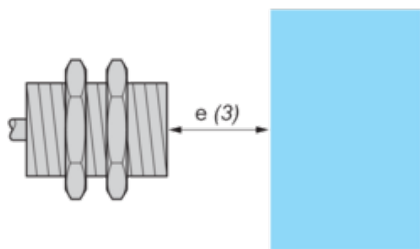

$e (3) \geq 30 \text{ mm}/1.18 \text{ in}$.

Wiring Schemes

3-wire DC

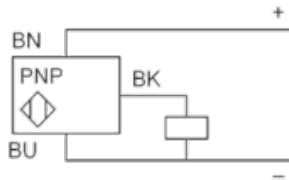

BU : Blue
BN : Brown
BK : Black

Performance Curves

Standard Steel Target : 30x30x1 mm

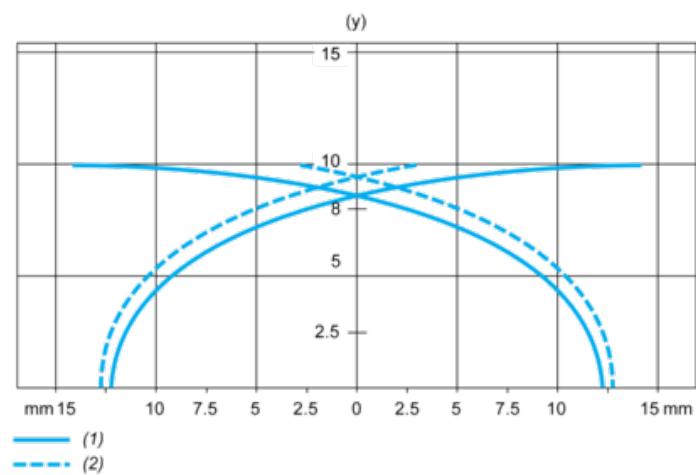

(1) Pick-up points

(2) Drop-out points (object approaching from the side)

(y) Sensing distance in mm