

# XSAV31801

Inductive proximity sensors XS, Rotation monitoring, M30, Sn10mm, 6...150c/mn, 24...240VAC/DC, cable 2 m



## Main

Range of product	Telemecanique Inductive proximity sensors XS
Series name	Application
Product or component type	Sensor
Sensor type	Inductive proximity sensor
Device application	Rotation monitoring
Sensor name	XSA
Sensor design	Cylindrical M30
Size	81 mm
Body type	Fixed
Detector flush mounting acceptance	Flush mountable
Material	Metal
Enclosure material	Nickel plated brass
Type of output signal	Discrete
Wiring technique	2-wire
[Sn] nominal sensing distance	10 mm
Discrete output function	1 NC
Output circuit type	AC/DC
Electrical connection	Cable
Cable length	2 m
[Us] rated supply voltage	24...210 V DC 24...240 V AC 50/60 Hz
Switching capacity in mA	5...200 mA DC 5...350 mA AC
IP degree of protection	IP67 conforming to IEC 60529

## Complementary

Thread type	M30 x 1.5
Detection face	Frontal
Front material	PPS
Sensing range	> 8...15 mm
Adjustable frequency range	6...150 cyc/mn
Operating zone	0...8 mm
Differential travel	3...15% of Fr
Repeat accuracy	3% of Sr
Cable composition	2 x 0.34 mm <sup>2</sup>
Wire insulation material	PVC
Status LED	Output state: 1 LED (red)
Supply voltage limits	20...264 V AC/DC
Maximum residual current	1.5 mA open state
Switching frequency	<= 100 Hz
Maximum voltage drop	<5.7 V (closed)
Run-up delay at power-up	3 s reduce
Marking	CE
Threaded length	67 mm

Length	81 mm
Net weight	0.3 kg

## Environment

Product certifications	UL[RETURN]CSA[RETURN]CCC
Ambient air temperature for operation	-25...70 °C
Ambient air temperature for storage	-40...85 °C

## Packing Units

Unit Type of Package 1	PCE
Number of Units in Package 1	1

## Offer Sustainability

Sustainable offer status	Green Premium product
Circularity Profile	 <a href="#">End of Life Information</a>
California proposition 65	WARNING: This product can expose you to chemicals including: Diisononyl phthalate (DINP), which is known to the State of California to cause cancer, and Di-isodecyl phthalate (DIDP), which is known to the State of California to cause birth defects or other reproductive harm. For more information go to <a href="http://www.P65Warnings.ca.gov">www.P65Warnings.ca.gov</a>
For all Reach Rohs enquiries contact us at	<a href="mailto:sustainability@tesensors.com">sustainability@tesensors.com</a>

## Contractual warranty

Warranty	18 months
----------	-----------

## Dimensions

mm  
in.

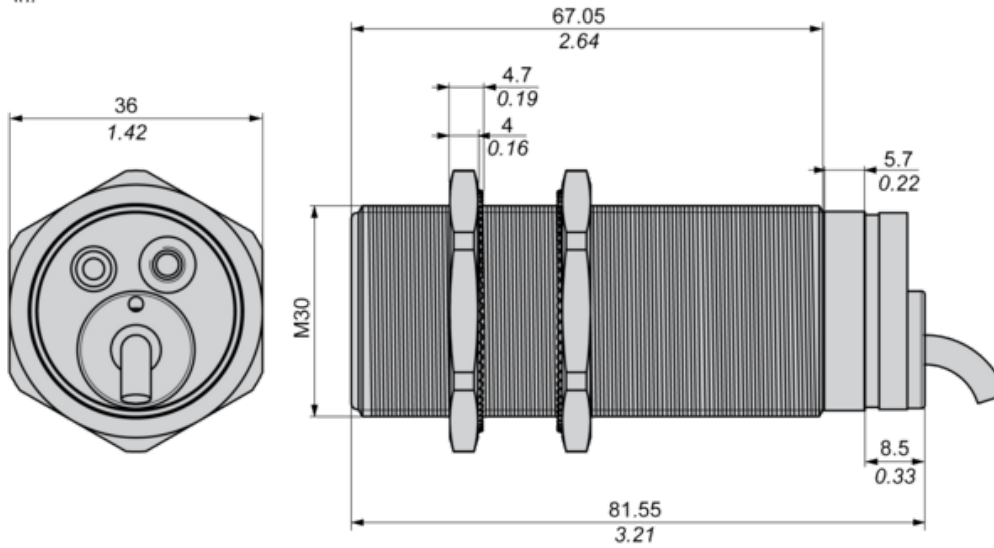

(1) LED

## Minimum Mounting Distances

Side by side

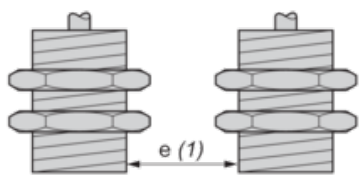

$e (1) \geq 20 \text{ mm}/0.79 \text{ in}$

Face to face

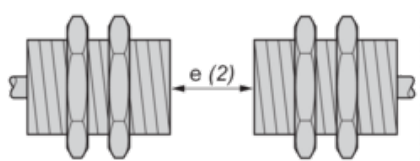

$e (2) \geq 120 \text{ mm}/4.72 \text{ in}$

Facing a metal object

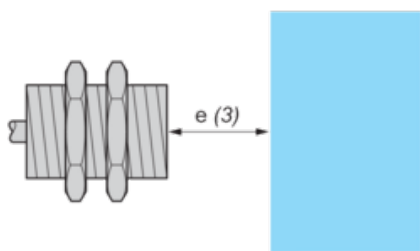

$e (3) \geq 30 \text{ mm}/1.18 \text{ in}$ .

---

## Wiring Schemes

---

2-wire AC or DC

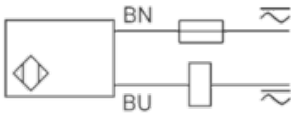

BU : Blue  
BN : Brown

---

Performance Curves

---

Standard Steel Target : 30x30x1 mm

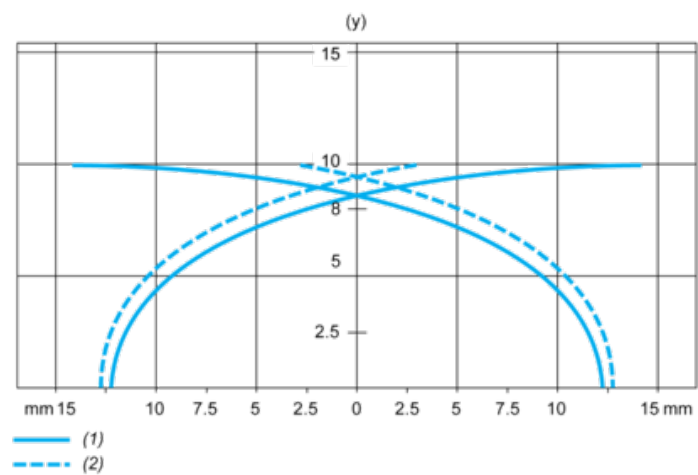

(1) Pick-up points

(2) Drop-out points (object approaching from the side)

(y) Sensing distance in mm