

# XCMH2102L1

## XCMH Limit Switches Miniature Plastic Metal Roller Plunger NC + NO Snap L1



### Main

|                               |  |
|-------------------------------|--|
| Range of product              | Telemecanique Limit switches XC Standard |
| Series name                   | Standard format                          |
| Product or component type     | Limit switch                             |
| Device short name             | XCMH                                     |
| Sensor design                 | Miniature                                |
| Body type                     | Fixed                                    |
| Head type                     | Plunger head                             |
| Material                      | Plastic                                  |
| Body material                 | Plastic                                  |
| Head material                 | Zamak                                    |
| Fixing mode                   | By the body                              |
| Movement of operating head    | Linear                                   |
| Type of operator              | Spring return roller plunger metal       |
| Type of approach              | Lateral approach, 2 directions           |
| Number of poles               | 2  |
| Contacts type and composition | 1 NC + 1 NO                              |
| Contact operation             | Snap action                              |

### Complementary

|  |   |
|--|---|
| Switch actuation                       | By 30° cam  |
| Electrical connection                  | Fixed cable   |
| Cable length                           | 1 m   |
| Cable composition                      | 4 x 0.34 mm <sup>2</sup>  |
| Wire insulation material               | PvR   |
| Contacts insulation form               | Zb  |
| Positive opening                       | With  |
| Positive opening minimum force         | 35 N  |
| Minimum force for tripping             | 7 N   |
| Maximum actuation speed                | 0.5 m/s   |
| Contact code designation               | C300, AC-15 (Ue = 240 V), Ie = 0.75 A conforming to IEC 60947-5-1 appendix A<br>R300, DC-13 (Ue = 250 V), Ie = 0.1 A conforming to IEC 60947-5-1 appendix A   |
| [Ui] rated insulation voltage          | 300 V (pollution degree 3) conforming to UL 508<br>300 V (pollution degree 3) conforming to IEC 60947-5-1<br>300 V (pollution degree 3) conforming to CSA C22.2 No 14   |
| Maximum resistance across terminals    | 25 MOhm conforming to IEC 60255-7 category 3  |
| [Uimp] rated impulse withstand voltage | 4 kV conforming to IEC 60664<br>4 kV conforming to IEC 60947-1  |
| Short-circuit protection               | 6 A cartridge fuse, type gG   |
| Electrical durability                  | 5000000 Cycles, DC-13, 120 V, 1 W, operating rate <60 cyc/mn, load factor: 0.5 conforming to IEC 60947-5-1 appendix C<br>5000000 Cycles, DC-13, 24 V, 3 W, operating rate <60 cyc/mn, load factor: 0.5 conforming to IEC 60947-5-1 appendix C<br>5000000 cycles, DC-13, 48 V, 2 W, operating rate <60 cyc/mn, load factor: 0.5 conforming to IEC 60947-5-1 appendix C |
| Mechanical durability                  | 5000000 cycles  |
| Width                                  | 30 mm   |
| Height                                 | 70.4 mm   |

The information provided in this documentation contains general descriptions and/or technical characteristics of the performance of the products contained herein. This documentation is not intended as a substitute for and is not to be used for determining suitability or reliability of these products for specific user applications. It is the duty of any such user or integrator to perform the appropriate and complete risk analysis, evaluation and testing of the products with respect to the relevant specific application or use thereof. Neither TWSS Holding nor any of its affiliates or subsidiaries shall be responsible or liable for misuse of the information contained herein.

|            |         |
|------------|---------|
| Depth      | 16 mm   |
| Net weight | 0.08 kg |

## Environment

|                                       |  |
|---------------------------------------|--|
| Shock resistance                      | 25 gn for 18 ms conforming to IEC 60068-2-27                           |
| Vibration resistance                  | 5 gn (f= 10...500 Hz) conforming to IEC 60068-2-6                      |
| IP degree of protection               | IP66 conforming to IEC 60529<br>IP67 conforming to IEC 60529           |
| IK degree of protection               | IK04 conforming to IEC 62262   |
| Electrical shock protection class     | Class II conforming to IEC 61140<br>Class II conforming to NF C 20-030 |
| Ambient air temperature for operation | -25...70 °C  |
| Ambient air temperature for storage   | -40...70 °C  |
| Protective treatment                  | TC   |
| Product certifications                | CSA[RETURN]CCC[RETURN]UL   |
| Standards                             | CSA C22.2 No 14<br>UL 508<br>IEC 60204-1<br>IEC 60947-5-1              |

## Packing Units

|                              |          |
|------------------------------|----------|
| Unit Type of Package 1       | PCE      |
| Number of Units in Package 1 | 1        |
| Package 1 Height             | 1.6 cm   |
| Package 1 Width              | 20 cm    |
| Package 1 Length             | 25 cm    |
| Package 1 Weight             | 70 g     |
| Unit Type of Package 2       | S02      |
| Number of Units in Package 2 | 30       |
| Package 2 Height             | 15 cm    |
| Package 2 Width              | 30 cm    |
| Package 2 Length             | 40 cm    |
| Package 2 Weight             | 3.894 kg |

## Offer Sustainability

|  |   |
|--|---|
| WEEE                                       | The product must be disposed on European Union markets following specific waste collection and never end up in rubbish bins   |
| California proposition 65                  | WARNING: This product can expose you to chemicals including: Diisononyl phthalate (DINP), which is known to the State of California to cause cancer, and Di-isodecyl phthalate (DIDP), which is known to the State of California to cause birth defects or other reproductive harm. For more information go to <a href="http://www.P65Warnings.ca.gov">www.P65Warnings.ca.gov</a> |
| For all Reach Rohs enquiries contact us at | <a href="mailto:sustainability@tesensors.com">sustainability@tesensors.com</a>  |

## Contractual warranty

|          |           |
|----------|-----------|
| Warranty | 18 months |
|----------|-----------|

Dimensions

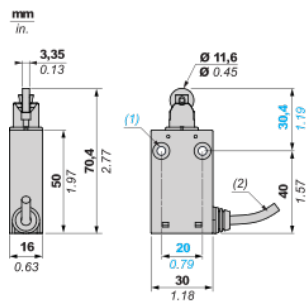

- (1) 2 fixing holes  $\varnothing$  4.2 mm (0.16 in.), counterbored  $\varnothing$  8 mm by 4 mm deep (counterbored  $\varnothing$  0.32 in. by 0.16 in. deep).
- (2) Cable external diameter: 4.2 mm (0.16 in.)

---

## Mounting and Clearance

---

### Mounting: distance required for connection

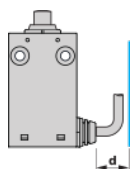

d : min.15 mm/min.0.59 in.

### Sweep of Connecting Cable

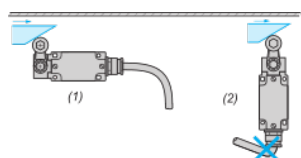

(1) : Recommended

(2) : To be avoided

### Mounting with Spacers

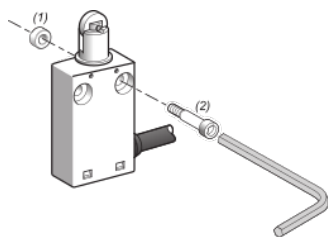

(1) : 2 spacers supplied with the switch

(2) : 2 screws Ø 4mm (not included)

---

Wiring diagram

---

2-pole NC + NO snap action

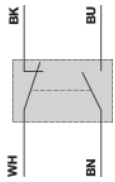

(BK) Black  
(WH) White  
(BN) Brown  
(BU) Blue

Characteristics of Actuation

Switch Actuation by 30° Cam

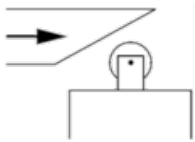

Functional Diagram

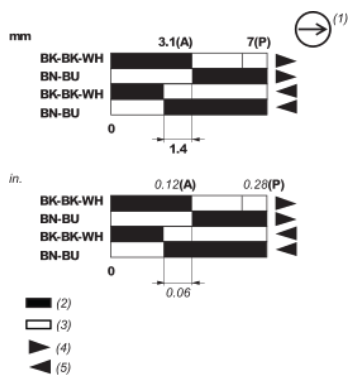

- (P) Positive opening point
- (A) Cam displacement
- (1) NC contact with positive opening operation
- (2) Closed
- (3) Open
- (4) Tripping
- (5) Resetting
- (BK) Black
- (BK-WH) Black White
- (BN) Brown
- (BU) Blue